

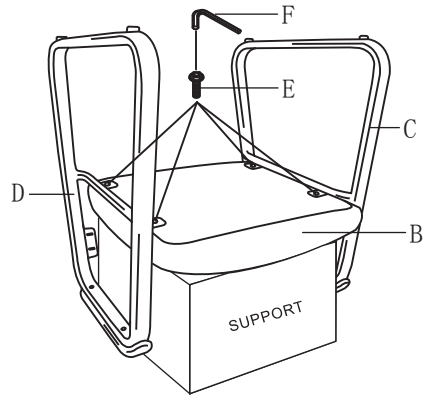

ASSEMBLY INSTRUCTIONS

1.



2.

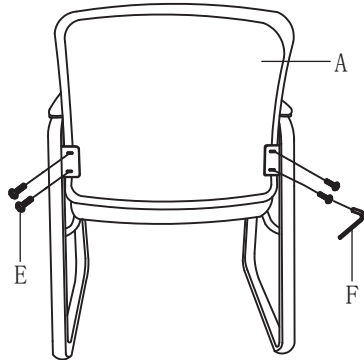

3.

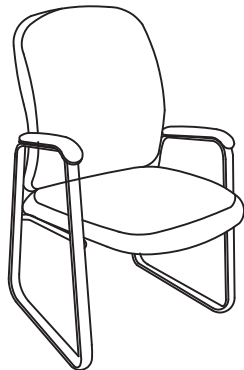

A.

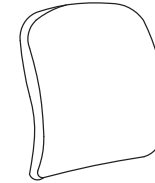

1 PC

D.

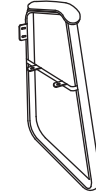

1 PC

B.



1 PC

E.

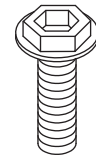

8 PCS

C.



1 PC

F.

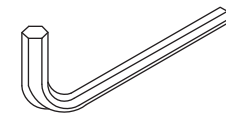

1 PC

Model: ALE-GE43LS10B

Manufactured for/ Hecho para/ Fabriqué pour Alera®/ USSCo,
1 Parkway North, Suite 100, Deerfield, IL 60015 ©2009 USSCo

Made in/ Hecho en/ Fabriqué en China

Product support and parts: 1-800-733-4000

Ayuda del producto y partes / Support technique et pieces